

The balance between inactivation and activation of the Na⁺-K⁺ pump underlies the triphasic accumulation of extracellular K⁺ during myocardial ischemia

Jonna R. Terkildsen,¹ Edmund J. Crampin,^{1,2*} and Nicolas P. Smith^{1,3*}

¹Auckland Bioengineering Institute and ²Department of Engineering Science, University of Auckland, Auckland, New Zealand; and ³Computing Laboratory, University of Oxford, Oxford, United Kingdom

Submitted 4 July 2007; accepted in final form 11 September 2007

Terkildsen JR, Crampin EJ, Smith NP. The balance between inactivation and activation of the Na⁺-K⁺ pump underlies the triphasic accumulation of extracellular K⁺ during myocardial ischemia. *Am J Physiol Heart Circ Physiol* 293: H3036–H3045, 2007. First published September 14, 2007; doi:10.1152/ajpheart.00771.2007.— Ischemia-induced hyperkalemia (accumulation of extracellular K⁺) predisposes the heart to the development of lethal reentrant ventricular arrhythmias. This phenomenon exhibits a triphasic time course and is thought to be mediated by a combination of three mechanisms: 1) increased cellular K⁺ efflux, 2) decreased cellular K⁺ influx, and 3) shrinkage of the extracellular space. These ischemia-induced electrophysiological changes are driven by an impaired cellular metabolism. However, the relative contributions of these mechanisms, as well as the origin of the triphasic profile, have proven to be difficult to determine experimentally. In this study, the changes in metabolite concentrations that arise during 15 min of zero-flow global ischemia were incorporated into a dynamic model of cellular electrophysiology, which was extended to include a metabolically sensitive description of the Na⁺-K⁺ pump and ATP-sensitive K⁺ channel, in addition to cell volume regulation. The coupling of altered K⁺ fluxes and cell volume regulation enables an integrative simulation of ischemic hyperkalemia. These simulations were able to quantitatively reproduce experimental measurements of the accumulation of extracellular K⁺ during 15 min of simulated ischemia, both with respect to the degree of K⁺ loss as well as the triphasic time course. Analysis of the model indicates that the inhibition of the Na⁺-K⁺ pump is the dominant factor underlying this hyperkalemic behavior, accounting for ~85% of the observed extracellular K⁺ accumulation. It was found that the balance between activation and inhibition of the Na⁺-K⁺ pump, affected by the changing metabolite and ion concentrations (in particular, [ADP]), give rise to the triphasic profile associated with ischemic hyperkalemia.

heart; mathematical model; extracellular potassium accumulation

MYOCARDIAL ISCHEMIA is characterized by the reduction of coronary flow such that cardiomyocytes are subject to inadequate oxygen and substrate supply and deficient waste removal. This produces an accumulation of ions and metabolites in the extracellular space. Within 30 s of the onset of ischemia, oxidative phosphorylation is inhibited, and comparatively inefficient anaerobic metabolism becomes the primary means of high-energy phosphate production (28) [with a concomitant accumulation of metabolic byproducts, such as protons, inorganic phosphate (P_i), and lactate (8, 27)]. Creatine phosphate (PCr) and glycogen-mediated ATP “buffering” maintains cel-

lular ATP levels for the initial period (12, 25, 28), but once these alternative energy sources are exhausted, the concentration of ATP declines until it eventually becomes insufficient to maintain myocyte function (28).

This disruption to the energetic status of the cardiomyocyte has a profound consequence upon both its contractility and electrophysiology. Notably, within seconds of the onset of zero-flow ischemia, K⁺ begins to accumulate in the extracellular space (hyperkalemia) with a characteristic triphasic profile (23, 34, 58, 69–72, 76). This takes the form of a rapid increase in the extracellular K⁺ (K_e⁺) concentration ([K⁺]_e) within 15–20 s, followed by a plateau phase wherein the concentration of K⁺ remains relatively constant. A subsequent slower accumulation of K⁺ is concurrent with inexcitability (6, 7, 69–71) and the onset of irreversible injury and cell death (71). While the details of the timing of these phases, and the [K⁺]_e attained, may vary between species and experimental conditions, the qualitative behavior is consistent throughout mammalian physiology (71).

The electrophysiological changes resulting from ischemic hyperkalemia include depolarization of the sarcolemma and an associated depression of cellular excitability, in addition to a shortening of the action potential duration. These changes predispose the myocardium to the development of lethal reentrant arrhythmias (13, 20, 26, 71). As a result, this phenomenon has been a topic of intense study and debate. Yet despite these investigations, the mechanism through which the triphasic accumulation of K_e⁺ arises remains controversial. When considering this phenomenon, there are two pertinent questions to consider. First, by what means does K_e⁺ accumulate, and second, what causes the distinct triphasic time course of accumulation?

Three discrete mechanisms are recognized as contributing to the disruption of K⁺ homeostasis during zero-flow ischemia. Specifically, an increase in unidirectional K⁺ efflux from the intracellular space, a decrease in unidirectional K⁺ influx into the intracellular space, and a shrinkage of the extracellular space. ATP-sensitive K⁺ (K_{ATP}) channels (47) are the primary mechanism through which unidirectional K⁺ efflux may increase during ischemia and contribute to the accumulation of K_e⁺ (32, 42, 58, 68, 72). However, the activation of these channels alone is insufficient to account for all of the observed K⁺ accumulation (32, 42, 57, 58, 68). This ischemic K⁺ efflux may also be augmented by the action of Na⁺-activated K⁺

*E. J. Crampin and N. P. Smith contributed equally to this work.

Address for reprint requests and other correspondence: J. R. Terkildsen, Auckland Bioengineering Institute, Univ. of Auckland, Lvl 6, 70 Symonds St., Auckland 1001, New Zealand (e-mail: j.terkildsen@auckland.ac.nz).

The costs of publication of this article were defrayed in part by the payment of page charges. The article must therefore be hereby marked “advertisement” in accordance with 18 U.S.C. Section 1734 solely to indicate this fact.

channels (6, 30, 52) and free-fatty acid K⁺ channels (6, 33, 71); however, the concentrations of intracellular Na⁺ (Na_i⁺) and free fatty acids required to activate these channels are reached only after prolonged ischemia (>15 min) (6, 33, 71). Other experimental evidence has suggested that the Na⁺-K⁺ pump is inhibited during ischemia (35, 43, 69) as a result of the reduction in free energy of ATP hydrolysis (14, 31) and thus is a mechanism contributing to the decrease in unidirectional K⁺ influx. The magnitude of this inhibition is as yet unquantified experimentally due to the difficulty of measuring the activity of this exchanger under ischemic conditions. Finally, the extracellular space has been shown to shrink during ischemia (15, 36, 75) as a result of the anaerobic metabolism-induced increase in intracellular osmolarity (leading to cell swelling) and the lack of diffusion from the extracellular space to the coronary circulation (29, 65). However, the contribution of this component to the observed increase in [K⁺]_e is thought to be comparatively small (71). While it is largely accepted that each of these features may contribute to an increase in [K⁺]_e, the quantitative extent to which each plays a role in the triphasic accumulation is poorly understood.

Understanding of the development of the triphasic accumulation profile (the second confounding feature of ischemic hyperkalemia), in particular the formation of the plateau phase, is currently lacking. Numerous hypotheses have been proposed in an attempt to explain this phenomenon. In regional myocardial ischemia, the formation of the plateau may partially be due to a balance between the K⁺ efflux from ischemic cells and a continuous removal of K⁺ from ischemic to healthy tissue via diffusion (6, 77). Yet the existence of a triphasic K_e⁺ accumulation in experimental constructs rendered globally ischemic (36, 69, 72) would suggest that this is not the primary mechanism. Alternatively, the plateau may be due to altered sarcolemmal K⁺ fluxes, namely, a transient decrease in K⁺ efflux and/or an increase in K⁺ influx. Theoretically, after an initial increase in K⁺ efflux, a K⁺-induced depolarization of the resting membrane potential (V_m) would decrease the driving force (V_m - E_K, where E_K is K⁺ Nernst potential) for K⁺ efflux and thus constrain the degree of K⁺ accumulation (71) potentially contributing to the formation of the plateau phase. Additionally, the activity of the Na⁺-K⁺ pump is governed by multiple competing stimuli during ischemia. Pump inhibition may be partially offset by the activating effect of both membrane depolarization and an increase in Na_i⁺ concentration ([Na⁺]_i) and [K⁺]_e. Thus, a semi-reactivated pump may also be implicated in the formation of the plateau phase (1, 69). To what extent each of these hypotheses is able to explain the triphasic accumulation of K_e⁺ is uncertain.

In contrast to the above hypotheses, in the first modeling study of this phenomenon, Rodriguez et al. (53–56) proposed that it is the simultaneous activation of the K_{ATP} current and inhibition of the Na⁺-K⁺ pump, combined with the onset of a depolarizing persistent Na⁺ current, that is required for the development of the plateau, finding that all three must be present to generate the plateau. This hypothesis is unable to account for the data of Wilde et al. (72), wherein guinea pig hearts, preperfused with the K_{ATP} channel blocker glybenclamide and subsequently rendered globally ischemic, still exhibited a triphasic accumulation of K_e⁺. If the hypothesis of Rodriguez et al. (55) were correct, the inactivation of the K_{ATP} channel in this ischemic preparation would preclude the onset

of the plateau phase and would obviate the possibility of a phasic accumulation.

In general, experimental analysis of ischemia has been hindered by the difficulty associated with the manipulation of ischemic preparations. In contrast, the use of mathematical modeling is a powerful quantitative tool for the study of this phenomenon (9, 11). It enables the individual mechanisms, and their influence upon the system as a whole, to be isolated and analyzed and subsequently related back to the available experimental data. In this study, we utilized a biophysically based cardiac cell model to investigate the phenomenon of hyperkalemia during global, zero-flow ischemia and its relation to the changing metabolic status of the cell. In particular, we focused on the dominant mechanisms acting within early ischemia, namely, the roles of the Na⁺-K⁺ pump, K_{ATP} channel, and changing cellular volume in the development of the triphasic profile.

METHODS

The model developed in this study is based on the Luo-Rudy dynamic (LRd) modeling framework of guinea pig cardiomyocyte electrophysiology (24, 39). This model represents the flow of ions through the major channels, transporters, and pumps as well as the separation of ions within intracellular subspaces and their binding to proteins and is formulated to ensure charge conservation. The concentrations of intra- and extracellular Na⁺ ([Na⁺]_i and [Na⁺]_e), K⁺ ([K⁺]_i and [K⁺]_e), and Ca²⁺ ([Ca²⁺]_i and [Ca²⁺]_e) are represented by dynamic variables, governed by a series of coupled differential equations.

Given their role as a link between cardiomyocyte metabolism and electrophysiology, the details included in the models of the Na⁺-K⁺ pump and K_{ATP} channel are very important for this study. Thus, the LRd cell model was extended to include biophysically accurate representations of these two ion transport mechanisms, dependent on both the ionic and metabolic status of the cell. A model of volume regulation was also developed and incorporated into the cell model. The key transmembrane fluxes and Ca²⁺-handling mechanisms included in the cell model are shown in Fig. 1. Full details of all model equations and parameters utilized in this study are listed in the *Supplementary Material*.¹ The following section presents the details of these model extensions and simulation parameters.

Na⁺-K⁺ pump. The LRd cell model was adapted to include a thermodynamically consistent model of the Na⁺-K⁺ pump, developed using the framework presented by Smith and Crampin (61). This model represents the 15 states of the Post-Albers cycle (Fig. 2) and is responsive to both ion concentrations (intra- and extracellular Na⁺ and K⁺) and metabolite concentrations (intracellular ATP, ADP, P_i, and H⁺) as well as V_m.

The Smith-Crampin Na⁺-K⁺ pump model was extended to provide a more detailed representation of the voltage dependence of Na⁺. Under physiological conditions, the voltage dependence is primarily associated with the binding and unbinding of one Na⁺ to the Na⁺-specific uncharged binding site (22, 38, 48). Thus, rather than assuming an identical binding affinity for all three Na⁺ and partitioning the voltage dependence over these “identical” reaction steps, it was assumed that two Na⁺ bind with equal affinity in a voltage-independent manner and one Na⁺ binds in a voltage-dependent manner (K_{d,Na_i}⁰ and K_{d,Na_e}⁰ in Fig. 2). Experimental data characterizing the pump current as a function of ion and metabolite concentrations (3, 17, 19, 45, 49) were used to reparameterize the modified Na⁺-K⁺ pump model. Preference was given to data obtained from ventricular

¹ Supplemental material for this article is available online at the *American Journal of Physiology-Heart and Circulatory Physiology* website.

Fig. 1. Schematic of the cell model and currents. I_{Na} , fast Na⁺ current; I_{NaB} , background Na⁺ current; I_{pNa} , plateau Na⁺ current; I_{NaCa} , Na⁺/Ca²⁺ exchanger; I_{CaB} , background Ca²⁺ current; I_{CaT} , T-type Ca²⁺ current; I_{CaL} , L-type Ca²⁺ current; I_{pCa} , sarcolemmal Ca²⁺ pump current; I_{KATP} , ATP-sensitive K⁺ (K_{ATP}) current; I_{Kp} , plateau K⁺ current; I_{K1} , time-independent K⁺ current; I_{Ks} , slow component of the delayed rectifier K⁺ current; I_{Kr} , rapid component of the delayed rectifier K⁺ current; I_{NaK} , Na⁺-K⁺ pump current; J_{H_2O} , transsarcolemmal water flux; JSR, junctional sarcoplasmic reticulum; NSR, network sarcoplasmic reticulum; CSQN, Ca²⁺ buffering by calsequestrin; TRPN, Ca²⁺ buffering by troponin; CMDN, Ca²⁺ buffering by calmodulin; I_{rel} , Ca²⁺ current through ryanodine receptors; I_{leak} , Ca²⁺ leak current; I_{tr} , Ca²⁺ flux between NSR and JSR; I_{up} , Ca²⁺ uptake through sarco(endo)plasmic reticulum Ca²⁺-ATPase.

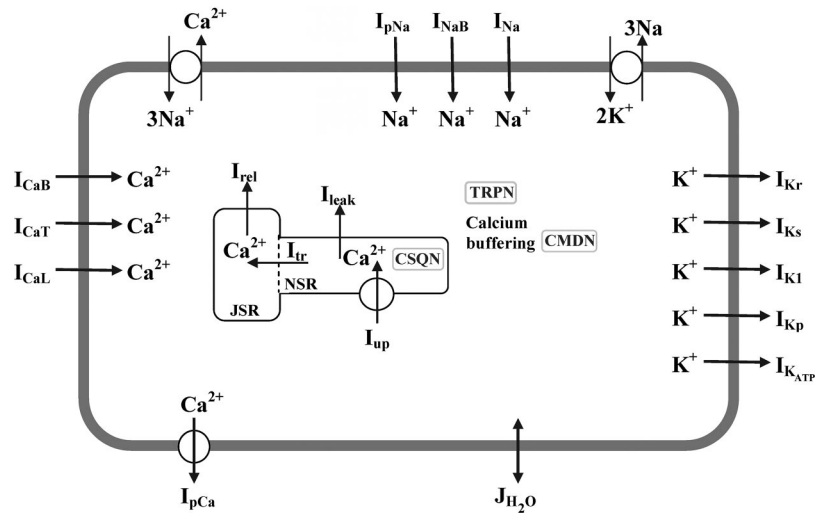

myocytes, primarily those from the guinea pig, using intra- and extracellular solutions whose composition was as near physiological as possible (details in *Supplementary Material*). Parameters were iteratively estimated using a sequential quadratic programming algorithm (16). In the absence of raw data characterizing the binding affinity of the pump molecule for ADP, a K_d of 6.3 mM [calculated from the ratio of forward and reverse rate constants, as reported by Peluffo (49)] was assumed.

Figure 3 shows the fit of the modified Smith-Crampin Na⁺-K⁺ pump model to experimental data characterizing ATP sensitivity (17) and $[Na^+]_e$ and V_m dependence (45) of the guinea pig Na⁺-K⁺ pump.

K_{ATP} channel. The LRd cell model was extended to include the Michailova et al. (41) description of the K_{ATP} channel. This model describes the biophysical interactions between channel subunits and ligands such that channel conductance is dependent on the concentrations of ATP and ADP and K_e^+ .

The published form of this model was designed to be integrated into the Winslow canine cardiac electrophysiology model (40, 74). To account for the species differences in channel conductance, model parameters were refitted to the guinea pig data of Nichols et al. (46), thus enabling the model to produce a current density consistent with the experimental data of that species.

Figure 4 shows the fit of the reparameterized Michailova et al. K_{ATP} channel model to the guinea pig data of Nichols et al. (46), demonstrating the sensitivity of the channel to intracellular ATP concentration normalized to the channel activity in the absence of ATP.

Volume regulation. Under conditions whereby the cardiomyocyte is subjected to an anisotonic environment, a water flux acts to relieve

the transmembrane osmotic pressure. The rate of change of the cell volume is proportional to this water flux (J_{H_2O}), which is described in Eq. 1 as follows:

$$J_{H_2O} = A_m L_p RT (\Pi_i - \Pi_e) \quad (1)$$

where A_m is the cell membrane area, L_p is the hydraulic conductivity of the membrane, R is the universal gas constant, T is the absolute temperature, and Π_i and Π_e are the intra- and extracellular osmotic pressures, respectively. These pressures are determined by the total number of osmotically active particles, both membrane-permeant ionic species as well as membrane-impermeant macromolecules. In the model presented, the intracellular osmolytes that are not explicitly accounted for are lumped together and are represented by the parameter $X_i^{z_i}$ (in mmol), with an average valance $-z_i$. Mathematically, Π_i is described in Eq. 2 as follows:

$$\Pi_i = \left([Na^+]_i + [K^+]_i + [Ca^{2+}]_{i,free} + \frac{X_i^{z_i}}{Vol_i} \right) \quad (2)$$

where Vol_i is the intracellular volume and $[Ca^{2+}]_{i,free}$ is the concentration of free, osmotically active Ca²⁺ in the cell. Similarly, Π_e may be calculated from the concentrations of extracellular ions. $X_e^{z_e}$ and extracellular osmolytes ($X_e^{z_e}$) were determined by the isotonicity equation, assuming that during normoxia, both intracellular and extracellular environments have an osmolarity of 310 mosM/l (29, 62, 65).

During ischemia, the intracellular osmolarity is known to increase as a result of the altered metabolism associated with this pathological condition (15, 29, 65, 75). In the absence of temporal data character-

Fig. 2. 15-State Post-Albers reaction cycle for the Na⁺-K⁺ pump (as described by the modified Smith-Crampin Na⁺-K⁺ pump model used in this study). Voltage dependence is partitioned between the binding and unbinding of the first Na⁺ (parameters $K_{d,Na1}^0$ and $K_{d,Nae}^0$).

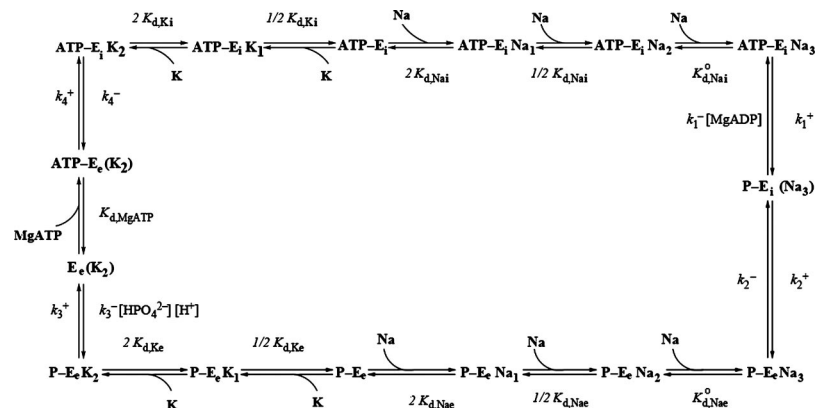

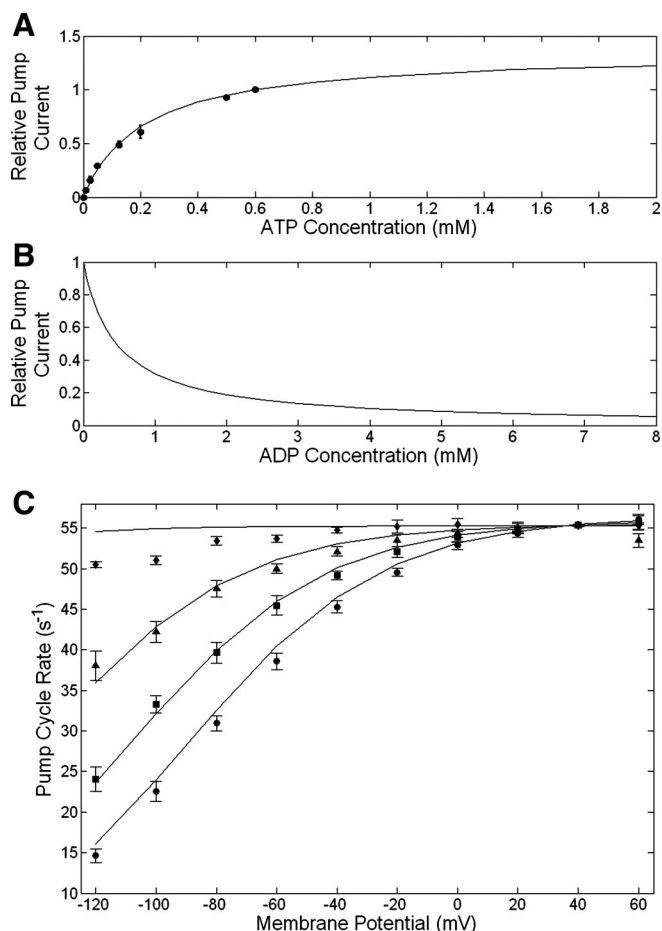

Fig. 3. A: fit of the Na⁺-K⁺ pump model to the data of Friedrich et al. (17) characterizing the affinity of the guinea pig cardiac Na⁺-K⁺ pump for ATP. B: predicted ADP dependence of the Na⁺-K⁺ pump model. C: fit of the Na⁺-K⁺ pump model (solid lines) to the data of Nakao and Gadsby (45) characterizing the dependence of the guinea pig cardiac Na⁺-K⁺ pump on membrane potential at varying extracellular Na⁺ concentrations (◆, [Na⁺]_e = 1.5 mM; ▲, [Na⁺]_e = 50 mM; ■, [Na⁺]_e = 100 mM; and ●, [Na⁺]_e = 150 mM).

izing this increase in osmolarity, the total cellular osmolarity (Π_i) was linearly interpolated over the 15-min duration of simulated ischemia from 310 mosM/l to the value of Tranum-Jensen et al. (65) of 325 mosM/l, and the cell volume varied accordingly.

Metabolite time courses. To create a model of ischemia based on the underlying bioenergetics, it is important to accurately represent the changes in metabolite concentrations. Metabolite (ATP concentration, PCr concentration, and pH_i) data during 15 min of zero-flow ischemia were obtained from the guinea pig ³¹P NMR spectroscopy experiments of Befroy et al. (4). The data points represent 4-min time averages and were interpolated to derive a time course of greater temporal resolution that was consistent with the data. Initial normoxic concentrations of PCr, Cr, and ATP were from Hartmann et al. (21), and the initial concentration of P_i was as measured by Zweier and Jacobus (78). To maintain species consistency, all data values were derived from experiments using guinea pigs.

Assuming that the relatively rapid creatine kinase buffering reaction remains close to equilibrium at all times, the concentration of ADP was calculated from the experimentally measured values of PCr, ATP, and pH using a creatine kinase buffering equilibrium constant of 1.66×10^9 M (37). Similarly, the concentration of AMP was determined from the adenylate kinase buffering reaction assuming an equilibrium constant of 1.05 (37). The assumption of total conserva-

tion of phosphate and creatine, as per Allen and Orchard (2), was used to determine the concentrations of P_i and Cr. Figure 5 shows the metabolite profiles over 15 min of ischemia.

While some metabolites are easily detectable by experimental techniques such as ³¹P NMR, data quantifying the changes (during ischemia) of metabolites that are undetectable by ³¹P NMR (for example, due to a low basal concentration, in the case of free ADP) are "hard to come by" and must thus be estimated according to mass-action kinetics from the experimentally determined metabolite time courses. The derived profile of ADP resulting from our equations is in agreement with that of Allen and Orchard (2).

RESULTS

To estimate the ability of this model of ischemia to reproduce the experimentally measured K_e⁺ accumulation observed by Wilde et al. (72), 15 min of global, zero-flow ischemia in guinea pig ventricular myocytes was simulated utilizing the cell model as described. The cell model was paced with a period of 300 ms using a 0.5 ms current stimulus of 80 μA/μF. The model was run to steady state in order to determine initial conditions to produce stable behavior over multiple action potentials, an important consideration for the simulation of pathological conditions such as ischemia that take place over an extended time period (10). Under normoxic conditions, it is presumed that the effect of the extracellular washout is such that the exchange between the extracellular clefts and the bulk medium is sufficiently rapid to ensure that the concentration of ions in the extracellular space are equal to the concentration in the bulk medium. In contrast, ischemia was imposed upon the model by preventing the diffusion between the extracellular space and the bulk medium (and enabling extracellular ion concentrations to vary dynamically according to the transmembrane ion fluxes) while the concentrations of metabolites were varied in the time-dependent manner shown in Fig. 5. Furthermore, during ischemia, the intracellular osmolarity was assumed to linearly increase, and the total volume of the intraplus extracellular volume fractions was assumed to be constant.

When all these ischemic conditions are imposed upon the cell model, K⁺ accumulates in the extracellular space in a triphasic manner, as shown in Fig. 6A. *Phase one* is charac-

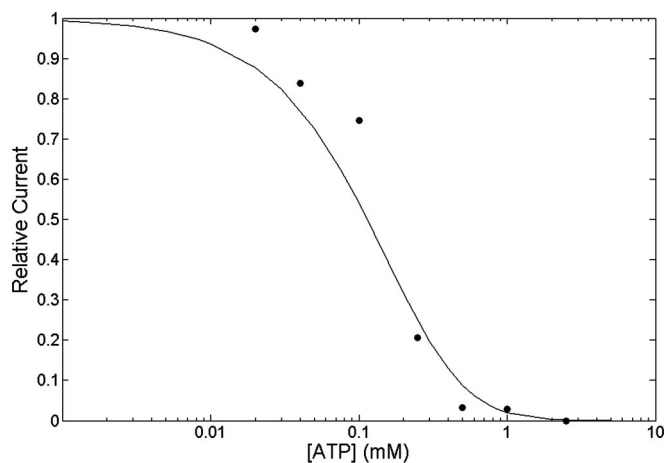

Fig. 4. Model of the reparameterized Michailova et al. K_{ATP} channel superimposed on the data of Nichols et al. (46) representing the sensitivity of the channel to intracellular ATP concentration normalized to the channel activity in the absence of ATP.

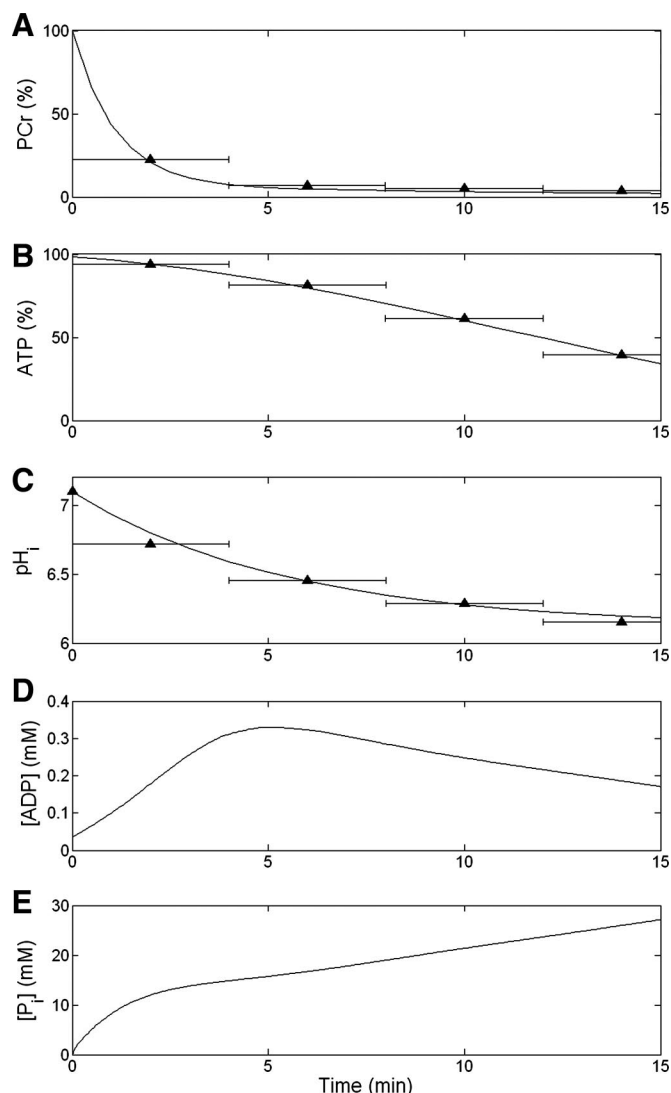

Fig. 5. Phosphocreatine (PCr; A), ATP (B), and intracellular pH (pH_i; C) during 15 min of global zero-flow ischemia [▲, data recreated from Befroy et al. (4)]. Concentrations of ADP (D) and P_i (E) were calculated as described in the text.

terized by a rapid increase in [K⁺]_e commencing within seconds of the onset of ischemia. During this initial phase, K_e⁺ accumulates to a concentration of 12 mM after 4 min. Following this increase, the rate of net cellular K⁺ efflux decreases such that the K⁺ accumulation enters the “plateau phase.” This second phase commences at ~4–5 min postonset and extends for some 5 min. The transition between this phase and the subsequent increase in K⁺ concentration is gradual. *Phase three* characterizes the second, slower increase in [K⁺]_e and continues for the remaining duration of ischemia. As shown in Fig. 6A, the model predicts that these three mechanisms are sufficient to account, not only qualitatively but also quantitatively, for the K⁺ accumulation measured by Wilde et al. (72) under identical, zero-flow ischemic conditions.

Furthermore, the ischemia-induced alterations to action potential morphology, such as a depolarization of the resting V_m, a decrease in maximum amplitude, a depression of excitability, and a significant shortening of the action potential duration, are

predicted by the simulations of this study (Fig. 7). This latter effect (the shortening of the action potential duration) is predominantly a result of the increased K⁺ conductance associated with the activation of the K_{ATP} channel (results not shown), consistent with both experimental (46, 57) and computational findings (46, 57, 59).

To elucidate the relative contributions of the three ischemic mechanisms to the development of the triphasic K_e⁺ time course, the effect on cellular behavior was simulated for each factor in turn. As shown in Fig. 6B, not only does the inhibition of the Na⁺-K⁺ pump result in a triphasic accumulation of K_e⁺, but it also accounts for ~85% of the total K_e⁺ accumulation. In contrast, the K_{ATP} current contributes (~15%) to the K_e⁺ accumulation during the initial phase of ischemia and relatively little during subsequent phases. This is consistent with the observations of Wilde et al. (72), whereupon the pretreatment of guinea pig hearts with glibenclamide (a K_{ATP} channel blocker) resulted in a reduction in the rate of K_e⁺ accumulation during the initial 5 min of ischemia, followed by a net K⁺ efflux that proceeded at approximately the same rate as the untreated ischemic measurements. Finally, the 15 mosM/l increase in intracellular osmolarity resulted in a 4.5% shrinkage of the extracellular space and a negligible effect (5%) on the total K_e⁺ accumulation.

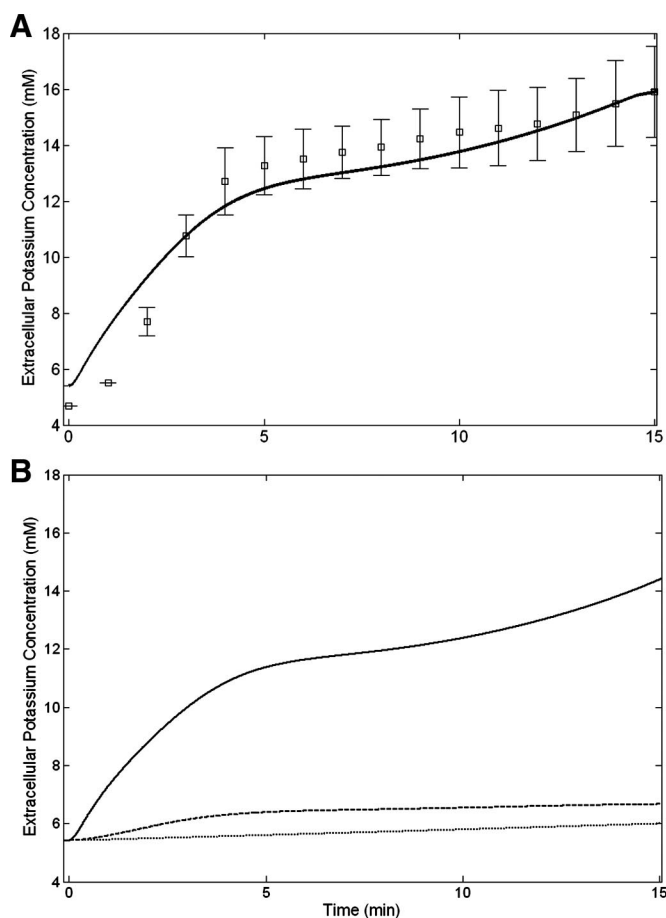

Fig. 6. A: extracellular K⁺ concentration predicted by the full cell model (solid line) superimposed on the data of Wilde et al. (Fig. 4C) (72). B: extracellular K⁺ concentration arising from the three distinct processes in the model: the modified Na⁺-K⁺ pump (solid line), the K_{ATP} channel (dashed line), and cellular osmolarity and volume (dotted line).

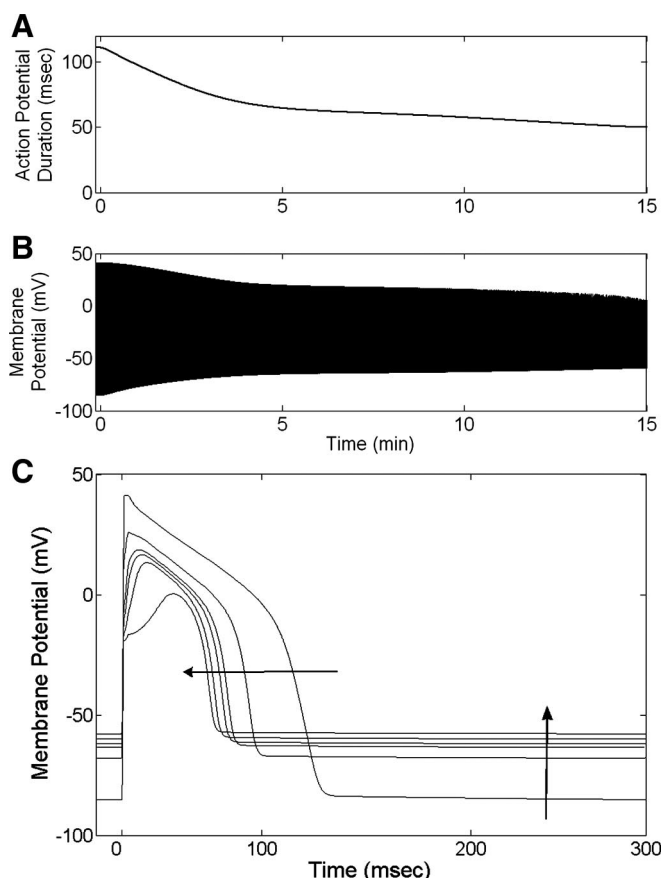

Fig. 7. *A*: action potential duration (90% repolarization). *B*: membrane potential over 15 min of simulated ischemia. *C*: action potential morphology at 0, 3, 6, 9, 12, and 15 min postonset. Action potentials were overlaid such that the time of maximum upstroke velocity corresponded to 0 ms. Arrows demonstrate the shortening of the action potential duration and the elevation of the resting membrane potential with the progression of time.

The above analysis highlights the importance of the inhibition of the Na⁺-K⁺ pump in both the severity of the K_e⁺ accumulation and its triphasic nature. This latter effect results from the triphasic inhibition profile of the pump activity (Fig. 8) as a consequence of metabolic changes. The rapid (and relatively severe) inhibition of the pump is consistent with the conclusions of Mitani and Shattock (43), who hypothesized that the activity of the Na⁺-K⁺ pump is significantly depressed immediately following the onset of ischemia, such that the application of the pump inhibitor ouabain failed to elicit a change in

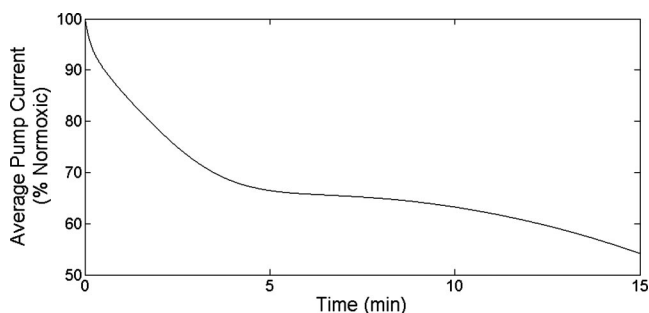

Fig. 8. Average pump current per beat (%normoxic) over 15 min of simulated ischemia.

the K_e⁺ accumulation during the initial phase of ischemia. Furthermore, the retention of partial Na⁺-K⁺ pump functionality over this time course is also well characterized by the inhibition shown in Fig. 8, in agreement with the experimental results of Kléber (35) and Weiss and Shine (69).

To understand which stimulatory and inhibitory metabolic factors are most influential on the Na⁺-K⁺ pump cycling rate, the average pump amplitude per beat was used as a metric of pump function. By isolating each element (while the remaining elements were kept constant at their preischemic values), this analysis provided the ability to estimate the individual and combined effects of changing metabolite concentrations upon net pump activity during ischemia. The contributions of these factors to the development of each of the three phases is analyzed below.

Phase one. The pump amplitude declined rapidly during *phase one* of simulated ischemia to a level ~65% of normoxic pump current. This inhibition was predominantly accomplished by the binding of ADP to the pump enzyme. In fact, as shown in Fig. 9A, the suppressive effect caused by changing [ADP] alone was sufficient to decrease the pump current to ~62% of its normoxic value within this initial phase. Reinforcing this inhibition was the inhibitory effect caused by the rapid accumulation of P_i during the first 2 min of ischemia (a byproduct of the degradation of the labile PCr molecules). The accumulation of protons also served to suppress the pump current but predominantly in the latter part of *phase one*; in contrast, the increase in [Na⁺]_i and [K⁺]_e served to stimulate pump activity (data not shown).

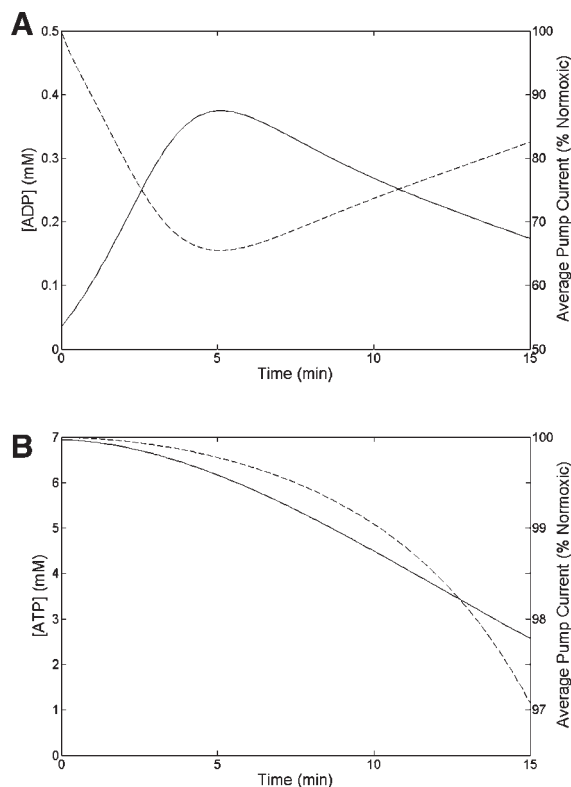

Fig. 9. Effect of the modification of ADP (*A*) or ATP (*B*) on I_{NaK} during simulated ischemia (solid line). Current is presented as a percentage of that at normoxia. Metabolite concentrations (dashed line) were varied as described in the text.

Transition between phase one and phase two. Between 4.5 and 5.5 min postonset, the concentration of ADP peaked and subsequently began to decline (Fig. 9A). At this point, the inhibitory effects of ADP were alleviated, arresting the decrease in pump amplitude and thus commencing the plateau phase.

Phase two (the plateau phase). The plateau phase arose as result of the interaction between a number of factors. By 5 min postonset, the concentration of ATP had declined sufficiently to commence having a small impact on pump activity (Fig. 9B). This effect, in combination with those of P_i and pH_i, functioned to inhibit pump activity. Importantly, during this phase, the inhibition was offset not only by the stimulatory effects of Na_i⁺ and K_e⁺ accumulation but also by ADP-modulated effects, since the decrease in the concentration of this metabolite has a reactivating effect on the pump (Fig. 9A, between 4.5 and 10 min).

Phase three. The third phase arose simply due to a shift in the balance of the activators and inhibitors, such that net inhibition outweighs net activation. This was partially due to the decrease in ATP concentration, which, by *phase three*, was sufficiently low to elicit a small reduction in pump cycling rate. Concomitant with this decrease in ATP concentration was the increase in P_i concentration, which further exacerbated the pump inhibition. The gradual nature of this shift in the inhibition-activation balance explains the lack of a pronounced transition between *phases two* and *three* (in contrast to the transition between *phases one* and *two*).

DISCUSSION

Elucidation of the individual mechanisms (and underlying cause) of net K⁺ loss during ischemia is important for the understanding of arrhythmogenesis and the development of improved approaches to its treatment. The biophysically based mathematical cell model utilized in this study contains a level of detail sufficient to reproduce accurately cardiac electrophysiology during both normoxia and ischemia.

Wilde et al. (72) measured the accumulation of K_e⁺ during zero-flow global ischemia in excised guinea pig hearts. They observed a triphasic increase in [K⁺]_e over a period of 15 min. This behavior was able to be reproduced qualitatively and quantitatively by the three mechanisms outlined in this study (Fig. 6A). It is important to note that these data were not used to fit the model; that is, no attempt was made to maximize the goodness of fit of the model by adjustment of its parameters. On the contrary, the output of the model directly predicts the experimentally observed data. Both the experiments and simulations represent zero-flow ischemia, and the K⁺ accumulation under hypoxic or low-flow ischemic conditions would differ.

The study presented here has addressed both the source of the K_e⁺ accumulation and the triphasic nature, which we will now discuss in turn.

Role of the Na⁺-K⁺ pump in the degree of K_e⁺ accumulation. The main conclusion resulting from this simulation study is the observation that the inhibition of the Na⁺-K⁺ pump is the major driving force underlying the change in net K⁺ flux during ischemia. Previously, a number of hypotheses have been proposed in an attempt to understand this increase in net K⁺ flux. One such hypothesis is that of Wilde and Aksnes (71)

and Shivkumar et al. (60), who proposed that the change in net K⁺ flux during ischemia is a passive reflection of the modified net Na⁺ flux (to maintain bulk electroneutrality and osmotic equilibrium). The uncertainty regarding whether it is the Na⁺ or K⁺ fluxes that drive the other may be resolved unambiguously via our proposition that the inhibition of the pump is the driving force resulting in the observed changes in both of these ion fluxes. The predominant role of this transporter in the hyperkalemic response, as seen in the present study, supports this hypothesis. Furthermore, the mirroring of the Na_i⁺ and K_e⁺ accumulations (such that the sum of [Na⁺]_i and [K⁺]_e remains approximately constant at all times) observed both experimentally (14) and in the present simulations (results not shown) suggests that it is feasible that a similar conclusion of Na⁺-K⁺ pump dominance would be reached via an analysis of Na⁺ fluxes.

Role of the K_{ATP} channel in the degree of K_e⁺ accumulation. The activation of the K_{ATP} current contributes to the K_e⁺ accumulation predominantly in the first phase, as shown in experimental studies (58, 64, 72) and predicted by the simulations presented in the present study. Indeed, theoretical calculations by Wilde and Aksnes (71) suggest that the selective increase in K⁺ conductance per se would be self-limiting in nature (and thus would have a “saturating effect” subsequent to an initial increase in conductance, as observed in this study) unless combined with a depolarizing inward current [to maintain the driving force (V_m - E_K)].

Role of volume regulation in the degree of K_e⁺ accumulation. The 15 mosM/l increase in intracellular osmolarity over the 15-min duration of simulated ischemia imposed in this study results in a decrease of extracellular volume by 4.5%, increasing [K⁺]_e by 0.6 mM of the observed 10.5 mM increase. The small contribution that a change in extracellular volume has on total K_e⁺ accumulation observed in these simulations is supported by the experimental data of Yan et al. (75), who imposed 10 min of zero-flow ischemia on isolated rabbit papillary muscles and measured an 8.4 mM increase in [K⁺]_e, of which 0.8–0.9 mM was estimated to be a result of the shrinkage of the extracellular space.

Development of the triphasic K_e⁺ accumulation profile. The simulations of the present study suggest that the triphasic profile of K_e⁺ accumulation is primarily a reflection of the triphasic inhibition of the Na⁺-K⁺ pump, in accordance with its dominant role in effecting net K⁺ efflux. Interestingly, Bersohn et al. (5) measured Na⁺-K⁺ pump activity in vesicles isolated from the rabbit myocardium subject to ischemic conditions and observed a phasic pump inhibition over the duration of ischemia. While caution must be exercised in drawing direct parallels between these experiments and pump activity in situ in ischemic hearts, their results support the concept of a phasic inhibition of the Na⁺-K⁺ pump. Furthermore, the concept of a Na⁺-K⁺ pump-dominated triphasic profile agrees with the results of Weiss and Shine (69), who observed an abolition of the plateau phase upon preperfusion with the pump inhibitor acetylthiocholine, thus implicating a transient reactivation of the pump in the formation of the plateau phase.

It is important to place our conclusions in the context of the only previous mechanistic modeling study of this phenomenon. In contrast to our observed Na⁺-K⁺ pump-dominated triphasic K⁺ accumulation, Rodriguez et al. (55) observed an ischemic plateau phase in simulations only when all three of the

Na⁺-K⁺ pump, K_{ATP} channel, and persistent Na⁺ currents were modified, although the reason for this codependence on all three currents was not discussed. This contrasts with the results of the present study, whereby a triphasic accumulation was observed when the contribution of the Na⁺-K⁺ pump alone was considered. Significantly, our study differs in the means with which the change in the currents during ischemia is characterized. Rodriguez et al. used linear interpolations to model the activation and inhibition of the currents. This is mechanistically very different from the manner in which we have characterized the inhibition and activation of the Na⁺-K⁺ pump and K_{ATP} channel, which were explicitly modeled with metabolic dependencies and thus were driven directly by the underlying metabolism of the ischemic cell. Furthermore, Rodriguez et al. considered the effect of the persistent Na⁺ current upon K_e⁺ accumulation, finding that the modification of this current (along with modified Na⁺-K⁺ pump and K_{ATP} channel) is required for the plateau formation. When we incorporated this current into the ischemic cell model, the impact on the K_e⁺ accumulation was negligible (results not shown). Most importantly, our simulations have captured the observation in the experimental data of Wilde et al. that the triphasic accumulation of K_e⁺ may still occur in the absence of K_{ATP} activation, an observation that the earlier study (55) is unable to explain.

A major finding of our study is the importance of the concentration of ADP in eliciting both the rapid response of K_e⁺ accumulation to the decline of metabolism (at a time when the concentration of ATP is still maintained) and the subsequent time dependence of K_e⁺ accumulation. Under physiological concentrations, the majority of ADP is bound to macromolecules (e.g., actin monomers) (25) such that the basal concentration of metabolically active ADP is maintained at a very low level (on the order of 0.035 mM). In contrast, the concentration of PCr and ATP are on the order of tens of millimolars. As a result, a minor decrease in the concentration of these latter two metabolites would have a very significant effect on the concentration of ADP. This rapid and substantial increase in concentration is thus able to quickly exert a significant effect on those processes that are sensitive to [ADP], in this instance, the activities of the Na⁺-K⁺ pump and K_{ATP} channel. (A similar effect is observed with P_i, which is also maintained at a low basal level under physiological conditions and which is also a significant regulator of pump activity within the first minutes of ischemia.)

Experimentally, the triphasic profile of K_e⁺ accumulation is quantitatively altered by the level of glucose (51, 70, 73) and the availability of oxygen (67). This is consistent with the above hypothesis that the metabolic status is integral in determining the rate of K_e⁺ accumulation through the modulation of metabolite concentrations, in particular ADP. To elaborate this point, those experimental preparations that were preperfused with glucose-rich solutions would have high endogenous levels of glycogen, which may be used as a substrate for glycolysis (12), thus altering the balance of ADP production and utilization during a subsequent period of ischemia. The associated K_e⁺ accumulation would thus be modulated subject to the ADP-effected K_{ATP} activation and Na⁺-K⁺ inhibition. The implications of this hypothesis extend to situations of repeated ischemic insults whereby the duration of the preceding ischemic episode modulates the subsequent K_e⁺ increase (44). While

there are many additional factors under these conditions that contribute to this behavior, the ability of the cell to recover its metabolite concentrations and ATP-buffering capabilities following the ischemic insult may be intrinsic to the K_e⁺ accumulation through the aforementioned change of ADP concentration.

Given the proposed link between hyperkalemia and cellular metabolic status, it thus follows that the results presented are fundamentally dependent on the means of representing the metabolite concentrations during ischemia. The changes in these concentrations, as simulated in this study, are qualitatively in agreement with other studies (2, 18, 21, 25, 50, 63, 66). Furthermore, the influence of quantitatively small changes in metabolite concentrations (a 10% increase or decrease of individual metabolite concentrations) on both the qualitative and quantitative nature of the Na⁺-K⁺ pump inhibition is minor (data not shown). It thus follows that while the data of Befroy et al. (4) were chosen in this study, the approach would yield qualitatively similar results upon application to other data representing the change of these metabolites during ischemia.

In the ischemic myocyte, there exist many other elements that may influence both the metabolic status of the cell and cellular electrophysiology. Some of these, such as the activation of the persistent Na⁺ current and the inhibition of sarco-(endo)plasmic reticulum Ca²⁺-ATPase, were modeled and found to induce only a very small change in the rate of accumulation of K_e⁺. Other acidosis-induced Na⁺ currents would increase [Na⁺]_i, with a potential effect on Na⁺-K⁺ pump activity and thus K_e⁺ accumulation, but were not explicitly modeled in this study. However, as shown in Fig. 10, while a 10% increase in [Na⁺]_i (as may arise as a result of acidotic Na⁺ currents) has a quantitatively significant effect on Na⁺-K⁺ pump activity, this exchanger retains its qualitative triphasic inhibition profile, and thus one would expect a corresponding response in [K⁺]_e. In this study, we have not attempted a complete model of ischemia. Rather, we present a study of the K⁺ dynamics under ischemic conditions that is able to capture the important features of the hyperkalemic phenomenon in a manner that is consistent with experimental data and observed trends. Moreover, a mathematical modeling approach has been able to elucidate the mechanisms involved in the ischemic hyperkalemia phenomenon, revealing that it is

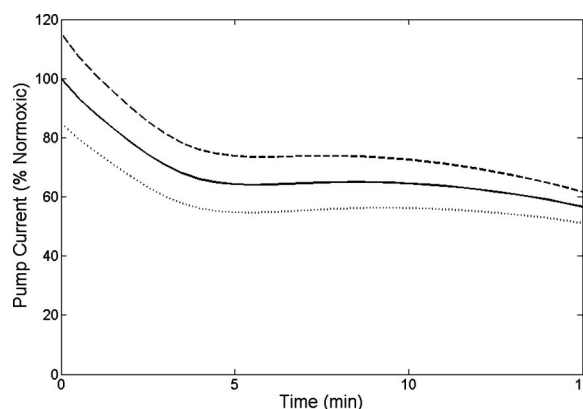

Fig. 10. Effect of a 10% variation in intracellular Na⁺ concentration on average I_{NaK} throughout 15 min of simulated ischemia. The Na⁺ concentration was increased (dashed line) or decreased (dotted line) by 10%.

the metabolic dependence of the Na⁺-K⁺ pump that is the critical element underlying the triphasic K⁺ accumulation.

ACKNOWLEDGMENTS

We thank Dr. Denis Loiselle for helpful comments.

GRANTS

This work was supported by Marsden Fund of the Royal Society of New Zealand Grant 04-UOA-177 and National Institute of Biomedical Imaging and Bioengineering Grant EB-005825.

REFERENCES

- Aksnes G. Why do ischemic and hypoxic myocardium lose potassium? *J Mol Cell Cardiol* 24: 323–331, 1992.
- Allen D, Orchard C. Myocardial contractile function during ischemia and hypoxia. *Circ Res* 60: 153–168, 1987.
- Bahinski A, Nakao M, Gadsby D. Potassium translocation by the Na⁺-K⁺ pump is voltage insensitive. *Proc Natl Acad Sci USA* 85: 3412–3416, 1988.
- Befroy D, Powell T, Radda G, Clarke K. Osmotic shock: modulation of contractile function, pH_i, and ischemic damage in perfused guinea pig heart. *Am J Physiol Heart Circ Physiol* 276: H1236–H1244, 1999.
- Bersohn M, Philipson K, Fukushima J. Sodium-calcium exchange and sarcolemmal enzymes in ischemic rabbit hearts. *Am J Physiol Cell Physiol* 242: C288–C295, 1982.
- Carmeliet E. Cardiac ionic currents and acute ischemia: from channels to arrhythmias. *Physiol Rev* 79: 917–1017, 1999.
- Cascio W, Yan GX, Kleber A. Passive electrical properties, mechanical activity, and extracellular potassium in arterially perfused and ischemic rabbit ventricular muscle. Effects of calcium entry blockade and hypercalcemia. *Circ Res* 66: 1461–1473, 1990.
- Clarke K, O'Connor A, Willis R. Temporal relation between energy metabolism and myocardial function during ischemia and reperfusion. *Am J Physiol Heart Circ Physiol* 253: H412–H421, 1987.
- Crampin E, Halsted M, Hunter P, Nielsen P, Noble D, Smith N, Tawhai M. Computational physiology and the physiome project. *Exp Physiol* 89: 1–26, 2004.
- Crampin E, Smith N. A dynamic model of excitation-contraction coupling during acidosis in cardiac ventricular myocytes. *Biophys J* 90: 3074–3090, 2006.
- Crampin E, Smith N, Langham A, Clayton R, Orchard C. Acidosis in models of cardiac ventricular myocytes. *Philos Transact A Math Phys Eng Sci* 364: 1171–1186, 2006.
- Cross H, Opie L, Radda G, Clarke K. Is a high glycogen content beneficial or detrimental to the ischemic rat heart? A controversy resolved. *Circ Res* 78: 482–491, 1996.
- Ferrero J Jr, Saiz J, Ferrero J, Thakor N. Simulation of action potentials from metabolically impaired cardiac myocytes: role of ATP-sensitive K⁺ current. *Circ Res* 79: 208–221, 1996.
- Fiolet J, Baartscheer A, Schumacher C, Coronel R, Ter Welle H. The change of the free energy of ATP hydrolysis during global ischemia and anoxia in the rat heart: its possible role in the regulation of transsarcolemmal sodium and potassium gradients. *J Mol Cell Cardiol* 16: 1023–1036, 1984.
- Fiolet J, Schumacher C, Baartscheer A, Coronel R. Osmotic changes and transsarcolemmal ion transport during total ischaemia of isolated rat ventricular myocytes. *Basic Res Cardiol* 88: 396–410, 1993.
- Fletcher R. *Practical Methods of Optimization*. New York: Wiley, 1987.
- Friedrich T, Bamberg E, Nagel G. Na⁺, K⁺-ATPase pump currents in giant excised patches activated by an ATP concentration jump. *Biophys J* 71: 2486–2500, 1996.
- Fukuda H, Luo C, Gu X, Guo LL, Digerness S, Li J, Pike M. The effect of K_{ATP} channel activation on myocardial cationic and energetic status during ischemia and reperfusion: role in cardioprotection. *J Mol Cell Cardiol* 33: 545–560, 2001.
- Hansen P, Buhagiar K, Kong B, Clarke R, Gray D, Rasmussen H. Dependence of Na⁺-K⁺ pump current-voltage relationship on intracellular Na⁺, K⁺, and Cs⁺ in rabbit cardiac myocytes. *Am J Physiol Cell Physiol* 283: C1511–C1521, 2002.
- Harris A, Bisteni A, Russell R, Bringham J, Firestone J. Excitatory factors in ventricular tachycardia resulting from myocardial ischemia. Potassium a major excitant. *Science* 119: 200–203, 1954.
- Hartmann M, Decking U, Schrader J. Cardioprotective actions of KC 12291. II. Delaying Na⁺ overload in ischemia improves cardiac function and energy status in reperfusion. *Naunyn Schmiedebergs Arch Pharmacol* 358: 554–560, 1998.
- Hilgemann D. Channel-like function of the Na,K pump probed at microsecond resolution in giant membrane patches. *Science* 263: 1429–1432, 1994.
- Hill J, Gettes L. Effect of acute coronary artery occlusion on local myocardial K⁺ activity in swine. *Circulation* 61: 768–778, 1980.
- Hund T, Kucera J, Otani N, Rudy Y. Ionic charge conservation and long-term steady state in the Luo-Rudy dynamic cell model. *Biophys J* 81: 3324–3331, 2001.
- Ingwall J. *ATP and the Heart*. Boston, MA: Kluwer Academic, 2002.
- Janse M, Wit A. Electrophysiological mechanisms of ventricular arrhythmias resulting from myocardial ischemia and infarction. *Physiol Rev* 69: 1049–1168, 1989.
- Jennings R, Ganote C, Reimer K. Ischemic tissue injury. *Am J Pathol* 81: 179–198, 1975.
- Jennings R, Reimer K. Lethal myocardial ischaemic injury. *Am J Pathol* 102: 241–255, 1981.
- Jennings R, Reimer K, Steenbergen C. Myocardial ischemia revisited. The osmolar load, membrane damage and reperfusion. *J Mol Cell Cardiol* 18: 769–780, 1986.
- Kameyama M, Kakei M, Sato R, Shibasaki T, Matsuda H, Irisawa H. Intracellular Na⁺ activates a K⁺ channel in mammalian cardiac cells. *Nature* 309: 354–356, 1984.
- Kammermeier H, Schmidt P, Jungling E. Free energy change of ATP-hydrolysis: a causal factor of early hypoxic failure of the myocardium? *J Mol Cell Cardiol* 14: 267–277, 1982.
- Kantor P, Coetzee W, Carmeliet E, Dennis S, Opie L. Reduction of ischemic K⁺ loss and arrhythmias in rat hearts: effect of glibenclamide, a sulfonylurea. *Circ Res* 66: 478–485, 1990.
- Kim D, Duff R. Regulation of K⁺ channels in cardiac myocytes by free fatty acids. *Circ Res* 67: 1040–1046, 1990.
- Kleber A. Extracellular potassium accumulation in acute myocardial ischemia. *J Mol Cell Cardiol* 16: 389–394, 1984.
- Kleber A. Resting membrane potential, extracellular potassium activity, and intracellular sodium activity during acute global ischemia in isolated perfused guinea pig hearts. *Circ Res* 52: 442–450, 1983.
- Knopf H, Theising R, Moon C, Hirche H. Continuous determination of extracellular space and changes of K⁺, Na⁺, Ca²⁺, and H⁺ during global ischaemia in isolated rat hearts. *J Mol Cell Cardiol* 22: 1259–1272, 1990.
- Lawson J, Veech R. Effects of pH and free Mg²⁺ on the K_{eq} of the creatine kinase reaction and other phosphate hydrolyses and phosphate transfer reactions. *J Biol Chem* 254: 6528–6537, 1979.
- Li C, Capendeguy O, Geering K, Horisberger JD. A third Na⁺-binding site in the sodium pump. *Proc Natl Acad Sci USA* 102: 12706–12711, 2005.
- Luo CH, Rudy Y. A dynamic model of the cardiac ventricular action potential. I. Simulations of ionic currents and concentration changes. *Circ Res* 74: 1071–1096, 1994.
- Michailova A, McCulloch A. Model study of ATP and ADP buffering, transport of Ca²⁺ and Mg²⁺, and regulation of ion pumps in ventricular myocyte. *Biophys J* 81: 614–629, 2001.
- Michailova A, Saucerman J, Belik M, McCulloch A. Modeling regulation of cardiac K_{ATP} and L-type Ca²⁺ currents by ATP, ADP, and Mg²⁺. *Biophys J* 88: 2234–2249, 2005.
- Mitani A, Kinoshita K, Fukamachi K, Sakamoto M, Kurisu K, Tsuruhara Y, Fukumura F, Nakashima A, Tokunaga K. Effects of glibenclamide and nicorandil on cardiac function during ischemia and reperfusion. *Am J Physiol Heart Circ Physiol* 261: H1864–H1871, 1991.
- Mitani A, Shattock M. Role of Na-activated K channel, Na-K-Cl co-transport, and Na-K pump in [K]_e changes during ischemia in rat heart. *Am J Physiol Heart Circ Physiol* 263: H333–H340, 1992.
- Mitani A, Yasui H, Tokunaga K. Effect of ischemic preconditioning on ischemia-induced contractile failure and accumulation of extracellular H⁺ and K⁺. *Jpn Circ J* 58: 894–902, 1994.
- Nakao M, Gadsby D. [Na] and [K] dependence of the Na/K pump current-voltage relationship in guinea pig ventricular myocytes. *J Gen Physiol* 94: 539–565, 1989.
- Nichols C, Ripoll C, Lederer W. ATP-sensitive potassium channel modulation of the guinea pig ventricular action potential and contraction. *Circ Res* 68: 280–287, 1991.

47. Noma A. ATP-regulated K⁺ channels in cardiac muscle. *Nature* 305: 147–148, 1983.
48. Or E, Goldshleger R, Karlish S. An effect of voltage on binding of Na⁺ at the cytoplasmic surface of the Na⁺-K⁺ pump. *J Biol Chem* 271: 2470–2477, 1996.
49. Peluffo R. Effect of ADP on Na⁺-Na⁺ exchange reaction kinetics of Na,K-ATPase. *Biophys J* 87: 883–898, 2004.
50. Pike M, Luo C, Clark M, Kirk K, Kitakaze M, Madden M, Cragoe E, Pohost G. NMR measurements of Na⁺ and cellular energy in ischemic rat heart: role of Na⁺-H⁺ exchange. *Am J Physiol Heart Circ Physiol* 265: H2017–H2026, 1993.
51. Rau E, Langer G. Dissociation of energetic state and potassium loss from anoxic myocardium. *Am J Physiol Heart Circ Physiol* 235: H537–H543, 1978.
52. Rodrigo G. The Na⁺-dependence of Na⁺-activated K⁺-channels [*I*_{K(Na)}] in guinea pig ventricular myocytes, is different in excised inside/out patches and cell attached patches. *Pflügers Arch* 422: 530–532, 1993.
53. Rodriguez B, Ferrero J Jr. *Integrated Mechanisms of K⁺ Loss in Myocardial Ischemia: a Simulation Study*. Istanbul, Turkey: IEEE/EMBS, 2001, p. 48–51.
54. Rodriguez B, Ferrero J Jr. Mechanistic investigation of the causes of cellular K⁺ loss during acute myocardial ischemia: a simulation study. *Comput Cardiol* 28: 361–364, 2001.
55. Rodriguez B, Ferrero J Jr, Trenor B. Mechanistic investigation of extracellular K⁺ accumulation during acute myocardial ischemia: a simulation study. *Am J Physiol Heart Circ Physiol* 283: H490–H500, 2002.
56. Rodriguez B, Ferrero J Jr, Trenor B, Ferrero J, Saiz J, Thakor N. *Simulation Study of the Contribution of the ATP-Dependent Potassium Current to Extracellular Potassium Accumulation During Myocardial Ischemia*. Hong Kong: IEEE/EMBS, 1998, p. 174–177.
57. Saito T, Sato T, Miki T, Seino S, Nakaya H. Role of the ATP-sensitive K⁺ channels in electrophysiological alterations during myocardial ischemia: a study using Kir6.2-null mice. *Am J Physiol Heart Circ Physiol* 288: H352–H357, 2005.
58. Sakamoto K, Yamazaki JN, T. 5-Hydroxydecanoate selectively reduces the initial increase in extracellular K⁺ in ischemic guinea-pig heart. *Eur J Pharmacol* 348: 31–35, 1998.
59. Shaw R, Rudy Y. Electrophysiological effects of acute myocardial ischemia: a theoretical study of altered cell excitability and action potential duration. *Cardiovasc Res* 35: 256–272, 1997.
60. Shivkumar K, Deutsch N, Lamp S, Khuu K, Goldhaber J, Weiss J. Mechanism of hypoxic K loss in rabbit ventricle. *J Clin Invest* 100: 1782–1788, 1997.
61. Smith N, Crampin E. Development of models of active ion transport for whole-cell modelling: cardiac sodium-potassium pump as a case study. *Prog Biophys Mol Biol* 85: 387–405, 2004.
62. Steenbergen C, Hill M, Jennings R. Volume regulation and plasma membrane injury in aerobic, anaerobic, and ischemic myocardium in vitro. Effects of osmotic cell swelling on plasma membrane integrity. *Circ Res* 57: 864–875, 1985.
63. Takayama E, Guo LL, Digerness S, Pike M. Early reperfusion levels of Na⁺ and Ca²⁺ are strongly associated with postischemic functional recovery but are disassociated from K_{ATP} channel-induced cardioprotection. *J Mol Cell Cardiol* 37: 483–496, 2004.
64. Thierfelder S, Doepner B, Gebhardt C, Hirche H, Benndorf K. ATP-sensitive K⁺ channels in heart muscle cells first open and subsequently close at maintained anoxia. *FEBS Lett* 351: 365–369, 1994.
65. Tranum-Jensen J, Janse M, Fiolet J, Krieger W, D'Almoncourt C, Durrer D. Tissue osmolality, cell swelling, and reperfusion in acute regional myocardial ischemia in the isolated porcine heart. *Circ Res* 49: 364–381, 1981.
66. Van Emous J, Nederhoff M, Ruigrok T, Van Echteld C. The role of the Na⁺ channel in the accumulation of intracellular Na⁺ during myocardial ischemia: consequences for post-ischemic recovery. *J Mol Cell Cardiol* 29: 85–96, 1997.
67. Vanheel G, De Hemptinne A. Influence of K_{ATP} channel modulation on net potassium efflux from ischaemic mammalian cardiac tissue. *Cardiovasc Res* 26: 1030–1039, 1992.
68. Venkatesh N, Lamp S, Weiss J. Sulfonylureas, ATP-sensitive K⁺ channels, and cellular K⁺ loss during hypoxia, ischemia, and metabolic inhibition in mammalian ventricle. *Circ Res* 69: 623–637, 1991.
69. Weiss J, Shine K. Extracellular K⁺ accumulation during myocardial ischemia in isolated rabbit heart. *Am J Physiol Heart Circ Physiol* 242: H619–H628, 1982.
70. Weiss J, Shine K. [K⁺]_o accumulation and electrophysiological alterations during early myocardial ischemia. *Am J Physiol Heart Circ Physiol* 243: H318–H327, 1982.
71. Wilde A, Aksnes G. Myocardial potassium loss and cell depolarisation in ischaemia and hypoxia. *Cardiovasc Res* 29: 1–15, 1995.
72. Wilde A, Escande D, Schumacher C, Thuringer D, Mestre M, Fiolet J, Janse M. Potassium accumulation in the globally ischemic mammalian heart: a role for the ATP-sensitive potassium channel. *Circ Res* 67: 835–843, 1990.
73. Wilde A, Peters R, Janse M. Catecholamine release and potassium accumulation in the isolated globally ischemic rabbit heart. *J Mol Cell Cardiol* 20: 887–897, 1988.
74. Winslow R, Rice J, Jafri S, Marban E, O'Rourke B. Mechanisms of altered excitation-contraction coupling in canine tachycardia-induced heart failure, II: model studies. *Circ Res* 84: 571–586, 1999.
75. Yan GX, Chen J, Yamada K, Kleber A, Corr P. Contribution of shrinkage of extracellular K⁺ accumulation in myocardial ischaemia of the rabbit. *J Physiol* 490: 215–228, 1996.
76. Yan GX, Yamada K, Kleber A, McHowat J, Corr P. Dissociation between cellular K⁺ loss, reduction in repolarization time, and tissue ATP levels during myocardial hypoxia and ischemia. *Circ Res* 72: 560–570, 1993.
77. Yi CS, Fogelson A, Keener J, Peskin C. A mathematical study of volume shifts and ionic concentration changes during ischemia and hypoxia. *J Theor Biol* 220: 83–106, 2003.
78. Zweier J, Jacobus W. Substrate-induced alterations of high energy phosphate metabolism and contractile function in the perfused heart. *J Biol Chem* 262: 8015–8021, 1987.